

# Data Sheet

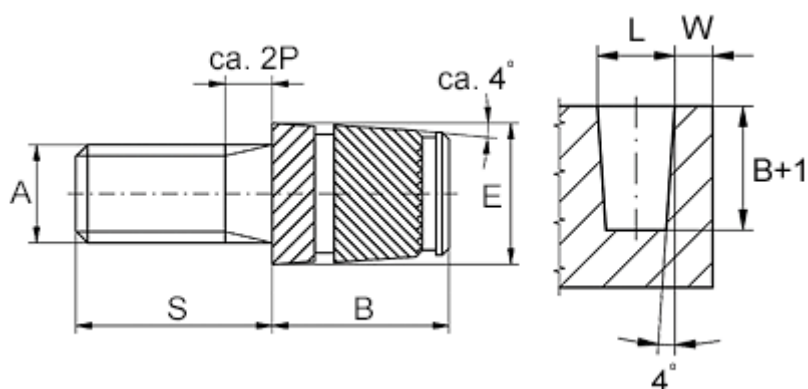

Article number: 12858100030860  
Description: KLEE-coil 858 100 030.860  
M3 Brass

## Measures



Male thread A	= M3x0,5
Min distance to edge W	= 1.8
Mounting length B	= 5.5
Outer diameter E	= 4.6
Pin length S	= 16
Recommended bore diameter W +0.1	= 4.4